



Type of installation	Surface, Wall mounted, Suspended
Light distribution	Direct, Direct-indirect
Colour of the luminaires	Black, Silver, White
Colour Temperature	3000 K warm white, 4000 K cool white
Material	Aluminium
Light source	LED MODUL
MacAdam Light source	2
Connection of the luminaires	ON/OFF DALI ON/OFF + 1h emergency Other type of dimming ON/OFF + 3h emergency
Lifetime	L80/B20, L80/B10 50 000 hours
Warranty	5 years

## Family

# Zuli

Do you remember the buzzing and flickering lights of your classroom? Fortunately these are long gone. Zuli pendant and surface-mounted LED luminaires ensure comfortable lighting in the classroom, offices and hospitals without these annoyances. These luminaires have direct or direct-indirect emission, with a choice of four lengths and microprism optics, grid and opal diffuser.

## Luminaire family variants Zuli

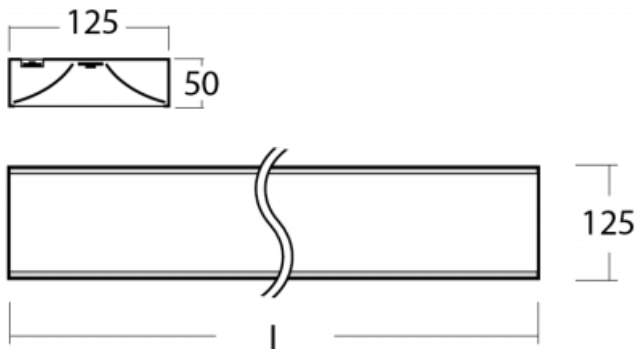

**Zuli**

**Assembly**

**Light distribution**

**Energy class**

energy\_class\_g

**Marks**

Code	Dimensions l/w/h (mm)	Power of the luminaire (W)	Luminous flux (lm)	Colour Temperature (K)	UGR
121-200K-20GEE/840, W	1145 × 125 × 50	21.4	3140	4000	< 23
121-200K-20GGE/840, W	1145 × 125 × 50	31.1	4310	4000	< 24.2
121-200K-25GEE/840, W	1425 × 125 × 50	26.8	3920	4000	< 23
121-200K-25GGE/840, W	1425 × 125 × 50	39.1	5390	4000	< 24.2
121-200K-30GEE/840, W	1705 × 125 × 50	32.1	4710	4000	-
121-200K-30GGE/840, W	1705 × 125 × 50	46.9	6470	4000	-
121-200K-40GEE/840, W	2265 × 125 × 50	42.8	6280	4000	-
121-200K-40GGE/840, W	2265 × 125 × 50	62.6	8630	4000	-

AnThese codes represent white luminaires with chromaticity temperature 4000K and opal diffuser.

Notes	Colour of the luminaires	● ● ●
	Colour Temperature	3000 K warm white 4000 K cool white
	Optic system	Microprisma Opal diffuser
	Connection of the luminaires	ON/OFF DALI ON/OFF + 1h emergency ON/OFF + 3h emergency
	Ra	80 90

Luminaires come complete with all necessary accessories.

## Zuli

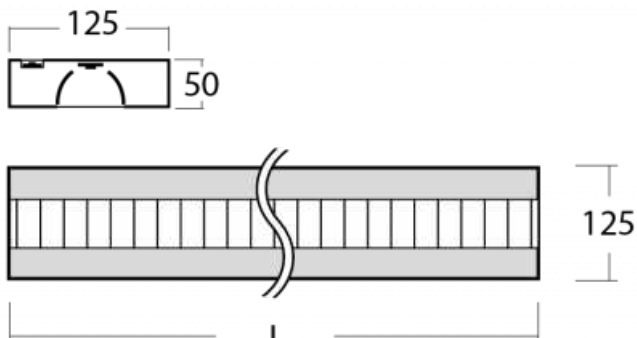
	Assembly	Light distribution
	Energy class	Marks
	energy_class_g	

Code	Dimensions l/w/h (mm)	Power of the luminaire (W)	Luminous flux (lm)	Colour Temperature (K)	UGR
121-230M-20GEE/840, W	1145 × 125 × 50	24.6	2910	4000	< 16.5
121-230M-20GGE/840, W	1145 × 125 × 50	33.8	3780	4000	< 17.4
121-230M-25GEE/840, W	1425 × 125 × 50	30.7	3640	4000	< 16.5
121-230M-25GGE/840, W	1425 × 125 × 50	42.2	4730	4000	< 17.4
121-230M-30GEE/840, W	1705 × 125 × 50	36.9	4370	4000	< 16.5
121-230M-30GGE/840, W	1705 × 125 × 50	50.7	5670	4000	< 17.4
121-230M-40GEE/840, W	2276 × 125 × 50	49.2	5830	4000	< 16.5
121-230M-40GGE/840, W	2276 × 125 × 50	67.6	7560	4000	< 17.4

AnThese codes represent white luminaires with chromaticity temperature 4000K and optical aluminium louvre.

Notes	Colour of the luminaires	
	Colour Temperature	3000 K warm white 4000 K cool white
	Optic system	Matt parabolic louvre
	Connection of the luminaires	ON/OFF DALI
	Ra	80

Luminaires come complete with all necessary accessories.

## Zuli

### Assembly



### Light distribution



### Energy class

energy\_class\_g

### Marks

Code	Dimensions l/w/h (mm)	Power of the luminaire (W)	Luminous flux (lm)	Colour Temperature (K)	UGR
121-200D-20GEE/840, W	1145 × 125 × 50	24.1	2850	4000	-
121-200D-20GGE/840, W	1145 × 125 × 50	33.7	3770	4000	-
121-200D-25GEE/840, W	1425 × 125 × 50	30.1	3560	4000	-
121-200D-25GGE/840, W	1425 × 125 × 50	42.1	4710	4000	-

The indicated codes stand for a white luminaire with colour temperature of 4000K.

Notes	Colour of the luminaires	
	Colour Temperature	3000 K warm white 4000 K cool white
	Optic system	Asymmetric reflector
	Connection of the luminaires	ON/OFF DALI
	Ra	80
Luminaires come complete with all necessary accessories.		

## Zuli

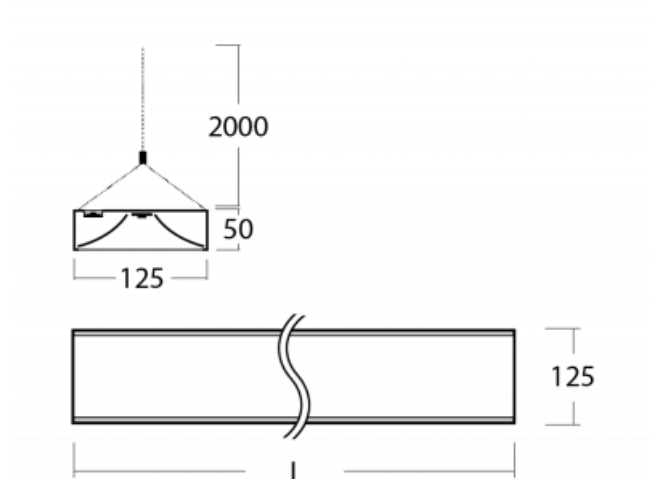

### Assembly



### Light distribution



### Energy class

energy\_class\_g

### Marks

Code	Dimensions l/w/h (mm)	Power of the luminaire (W)	Luminous flux (lm)	Colour Temperature (K)	UGR
121-500K-20GEE/840, W	1145 × 125 × 50	21.4	3140	4000	< 23
121-500K-20GGE/840, W	1145 × 125 × 50	31.1	4310	4000	< 24.2
121-501K-20GEE/840, W	1145 × 125 × 50	32	4530	4000	< 20.6
121-501K-20GGE/840, W	1145 × 125 × 50	46.7	6220	4000	< 21.8
121-500K-25GEE/840, W	1425 × 125 × 50	26.8	3920	4000	< 23
121-500K-25GGE/840, W	1425 × 125 × 50	39.1	5390	4000	< 24.2
121-501K-25GEE/840, W	1425 × 125 × 50	42.8	6020	4000	< 20.3
121-501K-25GGE/840, W	1425 × 125 × 50	62.6	8260	4000	< 21.4
121-500K-30GEE/840, W	1705 × 125 × 50	32.1	4710	4000	-
121-500K-30GGE/840, W	1705 × 125 × 50	46.9	6470	4000	-
121-501K-30GEE/840, W	1705 × 125 × 50	53.5	7500	4000	-
121-501K-30GGE/840, W	1705 × 125 × 50	78.2	10300	4000	-
121-500K-40GEE/840, W	2265 × 125 × 50	42.8	6280	4000	-
121-500K-40GGE/840, W	2265 × 125 × 50	62.6	8630	4000	-
121-501K-40GEE/840, W	2265 × 125 × 50	74.9	10470	4000	-
121-501K-40GGE/840, W	2265 × 125 × 50	109.5	14370	4000	-

AnThese codes represent white luminaires with chromaticity temperature 4000K and opal diffuser.

Notes	Colour of the luminaires	
	Colour Temperature	3000 K warm white 4000 K cool white
	Optic system	Microprisma Opal diffuser Clear cover
	Connection of the luminaires	ON/OFF DALI ON/OFF + 1h emergency Other type of dimming
	Ra	80

Luminaires come complete with all necessary accessories.

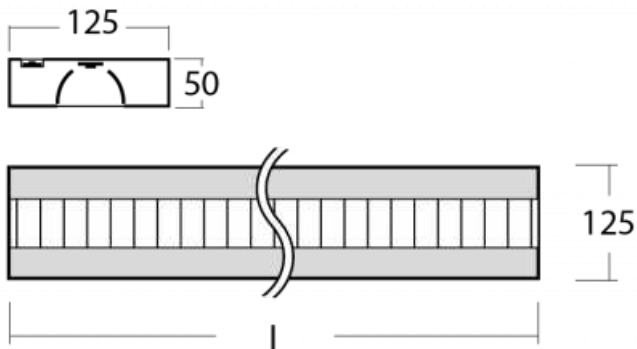
**Zuli**

**Assembly**

**Light distribution**

**Energy class**

energy\_class\_g

**Marks**

Code	Dimensions l/w/h (mm)	Power of the luminaire (W)	Luminous flux (lm)	Colour Temperature (K)	UGR
121-530M-20GEE/840, W	1145 × 125 × 50	24.6	2910	4000	< 16.5
121-531M-20GEE/840, W	1145 × 125 × 50	33.4	4300	4000	< 13.3
121-530M-20GGE/840, W	1145 × 125 × 50	33.8	3780	4000	< 17.4
121-531M-20GGE/840, W	1145 × 125 × 50	47.2	5780	4000	< 14
121-530M-25GEE/840, W	1425 × 125 × 50	30.7	3640	4000	< 16.5
121-530M-25GGE/840, W	1425 × 125 × 50	42.2	4730	4000	< 17.4
121-531M-25GEE/840, W	1425 × 125 × 50	44.5	5780	4000	< 12.9
121-531M-25GGE/840, W	1425 × 125 × 50	62.9	7770	4000	< 14
121-530M-30GEE/840, W	1705 × 125 × 50	36.9	4370	4000	< 16.5
121-530M-30GGE/840, W	1705 × 125 × 50	50.7	5670	4000	< 17.4
121-531M-30GEE/840, W	1705 × 125 × 50	55.6	7260	4000	< 12.7
121-531M-30GGE/840, W	1705 × 125 × 50	78.6	9760	4000	< 13.7
121-530M-40GEE/840, W	2276 × 125 × 50	49.2	5830	4000	< 16.5
121-530M-40GGE/840, W	2276 × 125 × 50	67.6	7560	4000	< 17.4
121-531M-40GEE/840, W	2276 × 125 × 50	77.8	10230	4000	< 12.4
121-531M-40GGE/840, W	2276 × 125 × 50	110	13740	4000	< 13.5

AnThese codes represent white luminaires with chromaticity temperature 4000K and optical aluminium louvre.

Notes	Colour of the luminaires	
	Colour Temperature	3000 K warm white 4000 K cool white
	Optic system	Matt parabolic louvre Clear cover
	Connection of the luminaires	ON/OFF DALI
	Ra	80

Luminaires come complete with all necessary accessories.

## Zuli

### Assembly



### Light distribution



### Energy class

energy\_class\_g

### Marks

Code	Dimensions l/w/h (mm)	Power of the luminaire (W)	Luminous flux (lm)	Colour Temperature (K)	UGR
121-500D-20GEE/840, W	1145 × 125 × 50	24.1	2850	4000	-
121-500D-20GGE/840, W	1145 × 125 × 50	33.7	3770	4000	-
121-501D-20GEE/840, W	1145 × 125 × 50	36.1	4420	4000	-
121-501D-20GGE/840, W	1145 × 125 × 50	50.6	5840	4000	-
121-500D-25GEE/840, W	1425 × 125 × 50	30.1	3560	4000	-
121-500D-25GGE/840, W	1425 × 125 × 50	42.1	4710	4000	-
121-501D-25GEE/840, W	1425 × 125 × 50	48.2	5920	4000	-
121-501D-25GGE/840, W	1425 × 125 × 50	67.4	7820	4000	-

The indicated codes stand for a white luminaire with colour temperature of 4000K.

Notes	Colour of the luminaires	
	Colour Temperature	3000 K warm white 4000 K cool white
	Optic system	Asymmetric reflector Clear cover
	Connection of the luminaires	ON/OFF DALI
	Ra	80
	Luminaires come complete with all necessary accessories.	

## Zuli

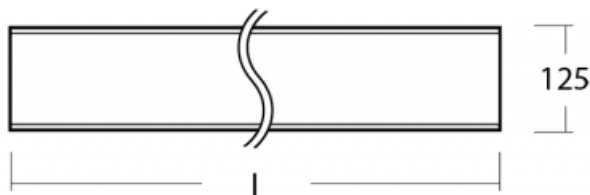
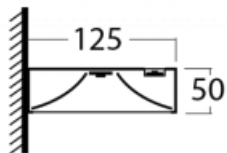

### Assembly



### Light distribution



### Energy class

energy\_class\_g

### Marks

Code	Dimensions l/w/h (mm)	Power of the luminaire (W)	Luminous flux (lm)	Colour Temperature (K)	UGR
121-301K-10GEE/840, W	590 × 125 × 50	16.2	2120	4000	< 18.1
121-301K-10GGE/840, W	590 × 125 × 50	26.6	3330	4000	< 19.7
121-301K-10GHE/840, W	590 × 125 × 50	40.6	4830	4000	< 21
121-301K-15GEE/840, W	865 × 125 × 50	24.2	3180	4000	< 18.2
121-301K-15GGE/840, W	865 × 125 × 50	39.7	4990	4000	< 19.8
121-301K-15GHE/840, W	865 × 125 × 50	60.9	7250	4000	< 21.1

AnThese codes represent white luminaires with chromaticity temperature 4000K and opal diffuser.

## Notes

Colour of the luminaires	
Colour Temperature	3000 K warm white 4000 K cool white
Optic system	Microprisma Opal diffuser Clear cover
Connection of the luminaires	ON/OFF DALI ON/OFF + 1h emergency ON/OFF + 3h emergency
Ra	80

Luminaires come complete with all necessary accessories.

## Legend

### Type of installation

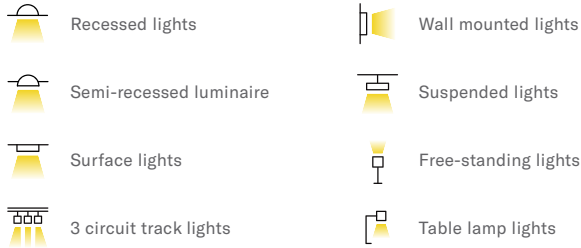

### Light distribution



### Light source

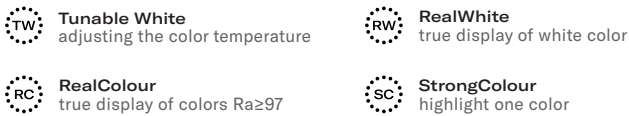

### Marks

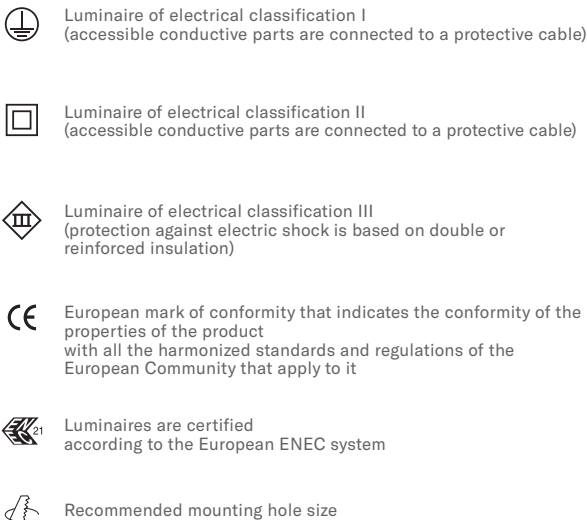

**IPxy** IP code indicating the degree of protection of live parts

**EAC** Eurasian Conformity

## 11S-501I-20GGE/840, W

11S-501I-20GGE/840, W

11S-501I-20GGE/840, W

11S-501I-20GGE/840, W

**Optic system**

**Electrical connection**

**Colour**











### Optic system

B	Microprismatic system, low UGR	L	Plain aluminium reflector
C	Clear cover	M	Matt parabolic louvre
D	Asymmetric reflector	S	SPOT - narrow angle
E	Polished parabolic louvre, high LOR	U	MEDIUM - middle angle
F	FLOOD - wide angle	W	Wide beam angle
I	Microprismatic optical system	Z	Plastic louvre, low UGR
K	Opal diffuser		

### Electrical connection

/BT	Luminaires controlled via Bluetooth technology	P	Sensor and electronic ballast
D	DALI dimmable	T	By switch dimmable (touch dimm)
E	Electronic ballast non-dimmable	TD	DALI or by switch (touch dimm) dimmable
M	Electronic ballast non-dimmable with 1h emergency	U	Dimmable luminaire with dimmer on the luminaire
M3	Electronic ballast non-dimmable with 3h emergency		

### Colour

W	 RAL 9003	B	 RAL 9005	S	 TIGER 09/90530
1021	 RAL 1021	2000	 RAL 2000	3020	 RAL 3020
5015	 RAL 5015	6018	 RAL 6018	7016	 RAL 7016
9006	 RAL 9006	9010	 RAL 9010		

### Značky typu

 Smart – Luminaire or the lighting system controlled by motion, daylight or via smart devices using Bluetooth technology

 Acoustic – Luminaire with acoustic absorption properties which reduce disturbing noise and improve the acoustics of the room

 Multiwatt – Luminaires with individually adjustable luminous flux using a special antenna or mobile application

UGR UGR – The luminaire suitable for office spaces